

Highly Accurate Non-contact Pyrometer With Analog Output and Digital Interface

CE 0°C to 1000°C AL30

AL30 Digital Infrared Pyrometers with Thermopile Sensors provides the advantage of noncontact temperature measurement of non-metallic surfaces, painted, coated or anodized metals etc. **AL30** IR Pyrometer is designed for easy integration into standard 4 wire system. This format combines the high accuracy of digital signal processing with the simple connection. **AL30** Infrared Pyrometer is used for target temperature ranging from 0°C to 1000°C. The electronic assembly is protected by IP 65 rugged stainless steel housing.

AL30 IR Thermometer is provided with USB 2.0 connector with cable. The Pyrometer can be powered through USB port. In this case no external power supply is required (24V DC requires for operation of analog output laser on and RS-232/RS-485 output).



Technical specifications

Model	AL30
Temperature Range (Analog sub-range adjustable)	0°C....1000°C 75°C...1000°C
Spectral Range	8 μm...14 μm
Photodetector Type	Thermopile
Distance to Spot Size Ratio	50:1 100:1
Emissivity (ε)	0.1....1.2 adjustable
Response Time	60 msec adjustable upto 10sec
Accuracy	T < 200°C; ± 1.5% of measured value or 3°C whichever is greater T ≥ 200°C; ± 1% of measured value or 4°C whichever is greater (The instrument must be at constant ambient temperature for minimum 25-30 mins in power on condition)
Repeatability	0.3% of reading in °C + 1°C
Sighting Option	Laser Pilot Light (PL)
Analog Output	0-20mA, 4-20mA, 0-10V (User selectable)
Digital Output	USB 2.0 RS-232/RS-485 (User selectable) *At a time only one digital output possible
Operating Temp. Range	0°C.....70°C 0°C.....200°C (With water cooling jacket)
Storage Temp. Range	-20°C...70°C
Adjustable Parameters and Features via Software	Emissivity, Response Time, Clear Time(Peak Picker), Analog Output, Analog Scale (Sub Range) , Unit Of Temperature(°C/°F), Communication mode (Comm.mode), Record feature etc
Power Supply	24V DC
Power Consumption	Max 2.5 watt
Laser Power	<1 m watt
Protection Class	IP65
Housing	Stainless Steel
Isolation	Power supply,*Digital output and Analog output are galvanically isolated against each other * Not applicable for USB 2.0 digital output
Operating Humidity	10-95%, Non-Condensing Conditions
Weight & Dimensions	600g Dia= Ø 49.5 mm; Length=118mm

Features

- Highly Accurate due to digital linearization of the output
- Temperature range from 0°C....1000°C
- Spectral range 8 μm...14 μm
- Four wire form with Analog output 4...20mA or 0...20mA or 0...10V
- Serial communication RS-232/RS-485
- Fast response time of 60 ms
- Very good stability
- Laser Targeting for precision targeting
- User friendly Software

Standard Scope of Supply

- Pyrometer with Laser pilot light(PL)
- Analog output 4...20mA, 0..20mA, 0..10V
- USB 2.0 Digital output, USB Cable
- Digital Interface RS-232 / RS-485(user selectable)
- 5 mtr long connection cable with connector
- 1.5 mtr. Communication Cable
- Calibration certificate, Software & Operation manual

Optional

- Mechanical & Electrical Accessories
- Extra Cable lengths

Applications

- Plastic
- Fluids
- Rubber
- Ceramic
- Wood
- Glass
- Coated metals
- Textiles

Spot Sizes

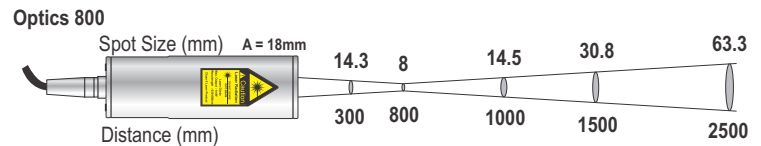
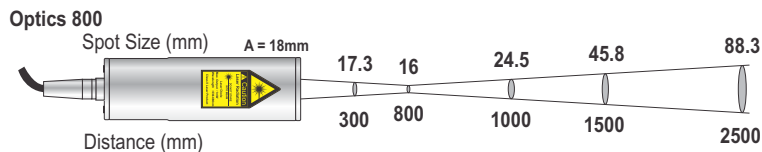
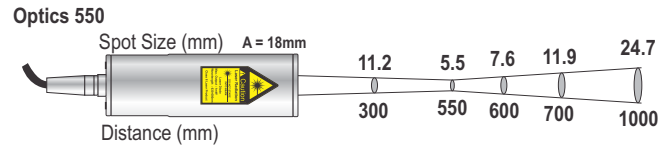
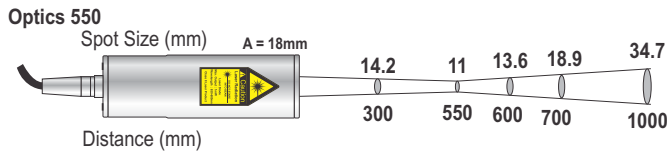
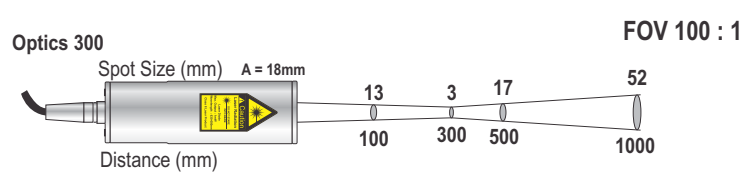
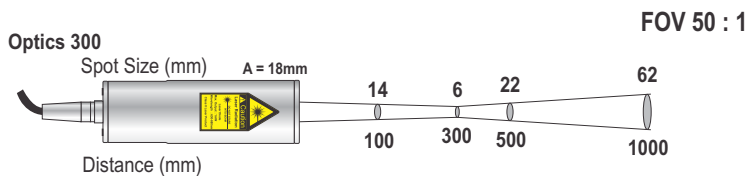

Software "Infrasoft"

AST "Infrasoft" software is under standard scope of supply. It offers possibilities of connecting three pyrometers simultaneously for parameter setting, view real time graph, offline graph and to evaluate measuring data. Communication between the pyrometer and the software is implemented via a cable connected between the pyrometer and the PC serial port. It comes with record feature, spot size calculator and parameter settings features.

Some of the parameters adjustable via software are

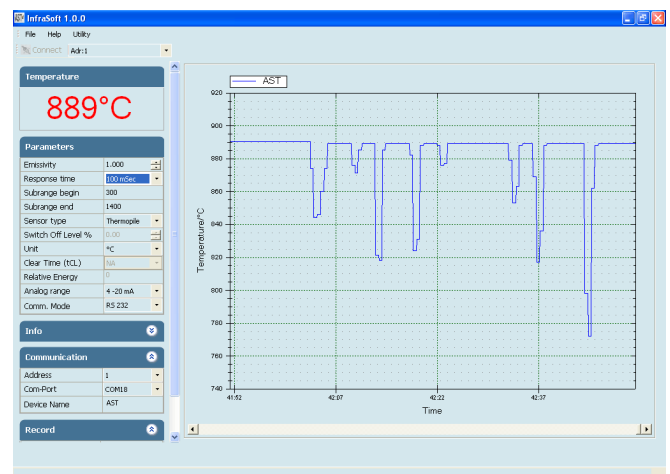

- Emissivity, Response Time,
- Clear Time(Peak Picker),
- Analog Output,
- Sub Range,
- Unit Of Temperature(°C/°F),
- Communication mode(Comm.mode).

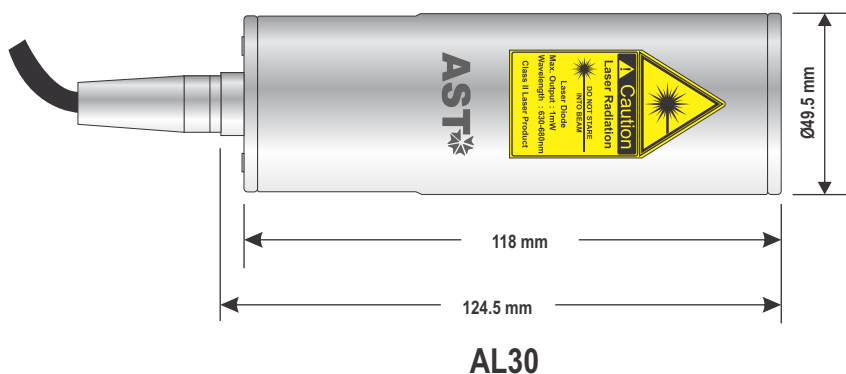

Pyrometer Drawing



Accessories

<p>Water Cooling Jacket with Adjustable Flange (Reference no: 8000-02 for PL) (Reference no: 8000-06 for TL)</p>	<p>Adjustable Mounting Stand (Reference no: 8000-07)</p>	<p>Air Purge Unit (Reference no: 8000-04)</p>	<p>Adjustable Mounting Support (Reference no: 8000-05)</p>
			
<p>Display & Parameterizer P-120 (Reference no: 9001-01)</p>	<p>Converter RS-232 ↔ RS-485 (Reference no: 9000-03)</p>	<p>Power Supply Unit (Reference no: 9000-02)</p>	<p>Temperature Indicator (Reference no: 9000-01)</p>
			

Pyrometer Accessories Drawings

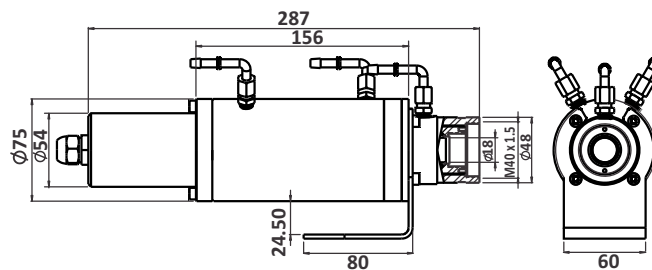

Water Cooling Jacket with Adjustable Flange PL
(Reference no: 8000-02)

FOR 6 mm INSIDE
DIAMETER HOSE

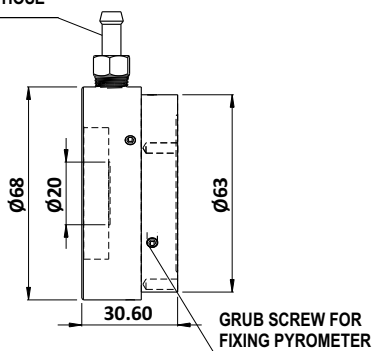

Air Purge Unit
(Reference no: 8000-04)

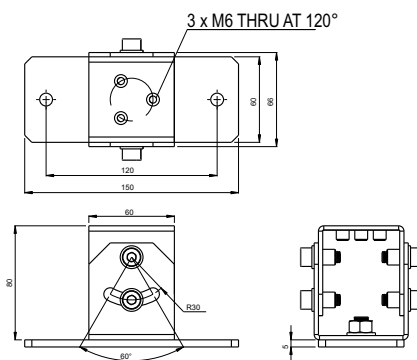

Adjustable mounting stand
(Reference no: 8000-07)

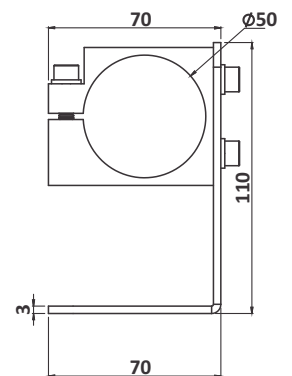

Mounting Clamp
(Reference no: 8000-05)



Tempsens Instruments (I) Pvt. Ltd. U# I
 B-188A, Road No.5, M.I.A.,
 Udaipur-313003 (Rajsthan) INDIA
 Ph.:+91-294-3057700 to 800
 Fax.:+91-294-3057750
 Email: info@tempsens.com

